

HOT WATER FIREPLACE INSERT BEF AQUATIC WH V 60 CP IN ACCORDANCE WITH EN 13 229

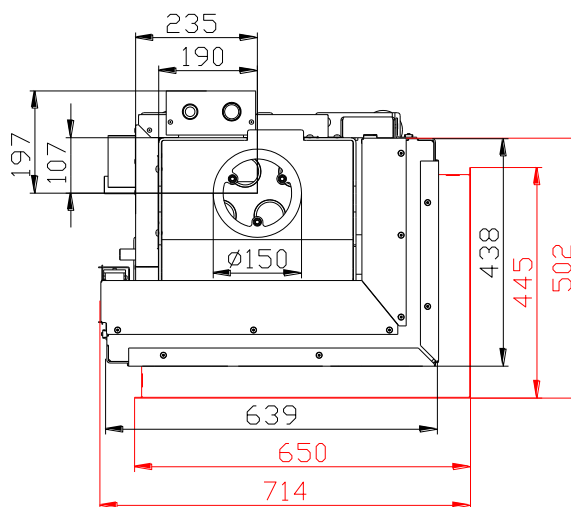
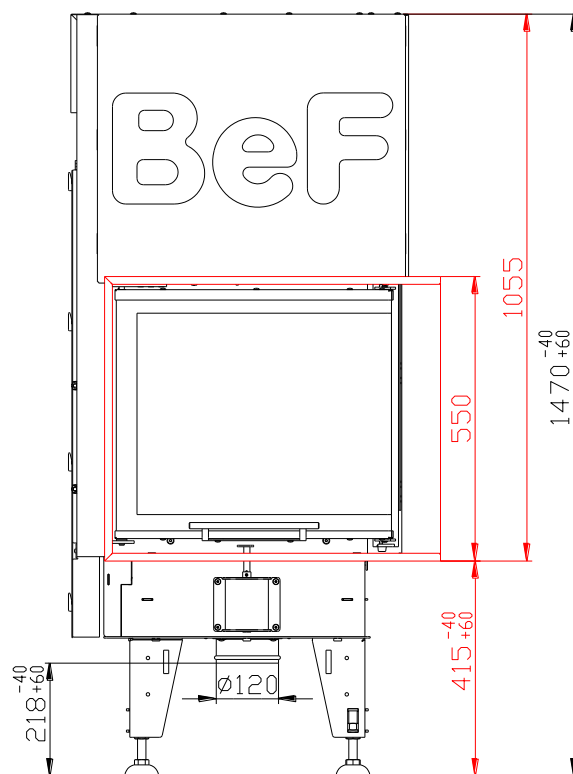
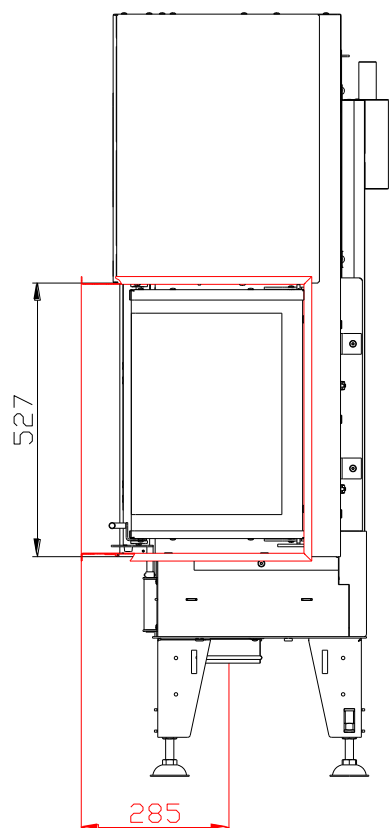

HOT WATER FIREPLACE INSERT BEF AQUATIC WH V 60 CP IN ACCORDANCE WITH EN 13 229

Technical data:

		Closed firebox
Nominal heat output	kW	9
Efficiency	%	86
Output into water	kW	4,8
Volume flow of combustion products	g/s	7,1
Flue-gas temperature	°C	210
Min. feed pressure at nominal heat output	Pa	12
Fuel		wood (beech logs)
Fuel consumption per hour	kg/h	2,81
CO emission in burnt gas (in relation to 13% O ₂)	%	0,07
Dust in flue-gas (in relation to 13% O ₂)	mg/Nm ³	23
Smoke flue diameter	mm	150
Weight	kg	161

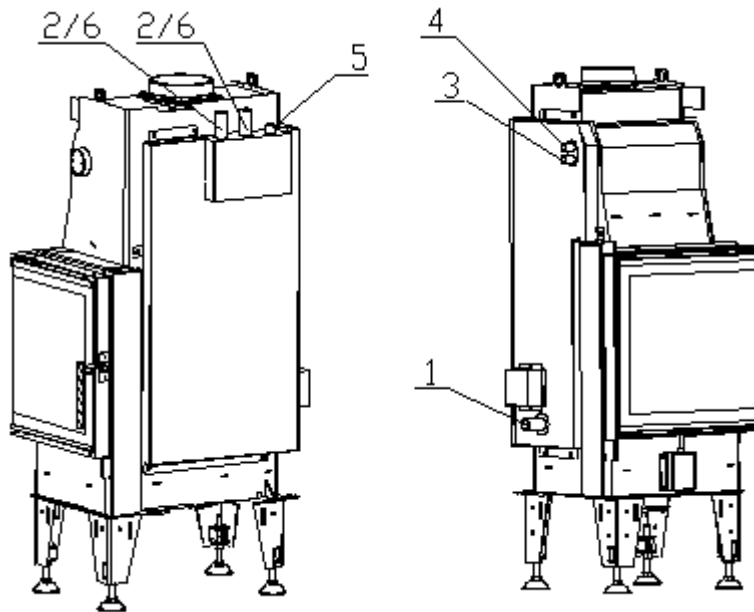

- 1 – Cold water input into water exchanger (reverse), external thread 1“
- 2 – Warm water output from water exchanger (rising pipe), external thread 1“
- 3 – Cold water input for coolant loop , external thread 1/2“
- 4 – Warm water output from coolant loop, external thread 1/2“
- 5 – Input for bleed valve, internal thread 1/2”
- 6 – Thermic security sensor, internal thread 1”

Set of carcon firebox:

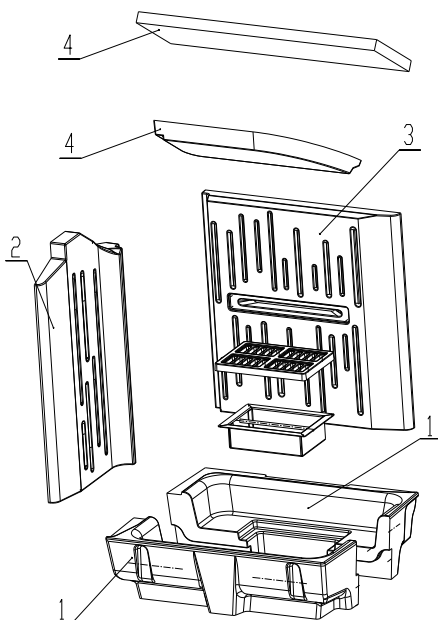

List of spare parts:

- 1. Bottom
- 2. Side piece
- 3. Back
- 4. Deflector
- 5. Cast iron grate
- 6. Ashtray

For details see Installation and Service Instructions.