

12b

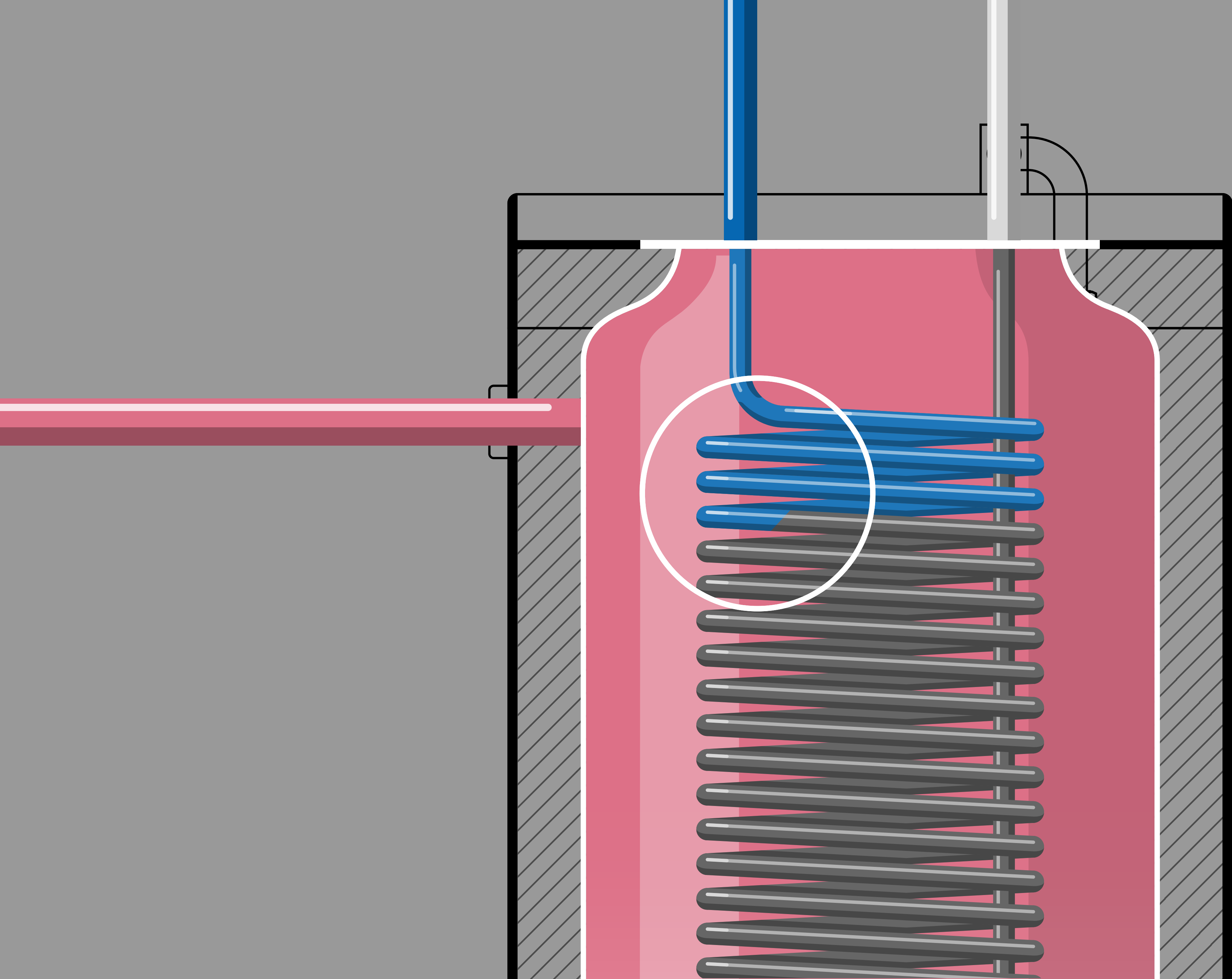

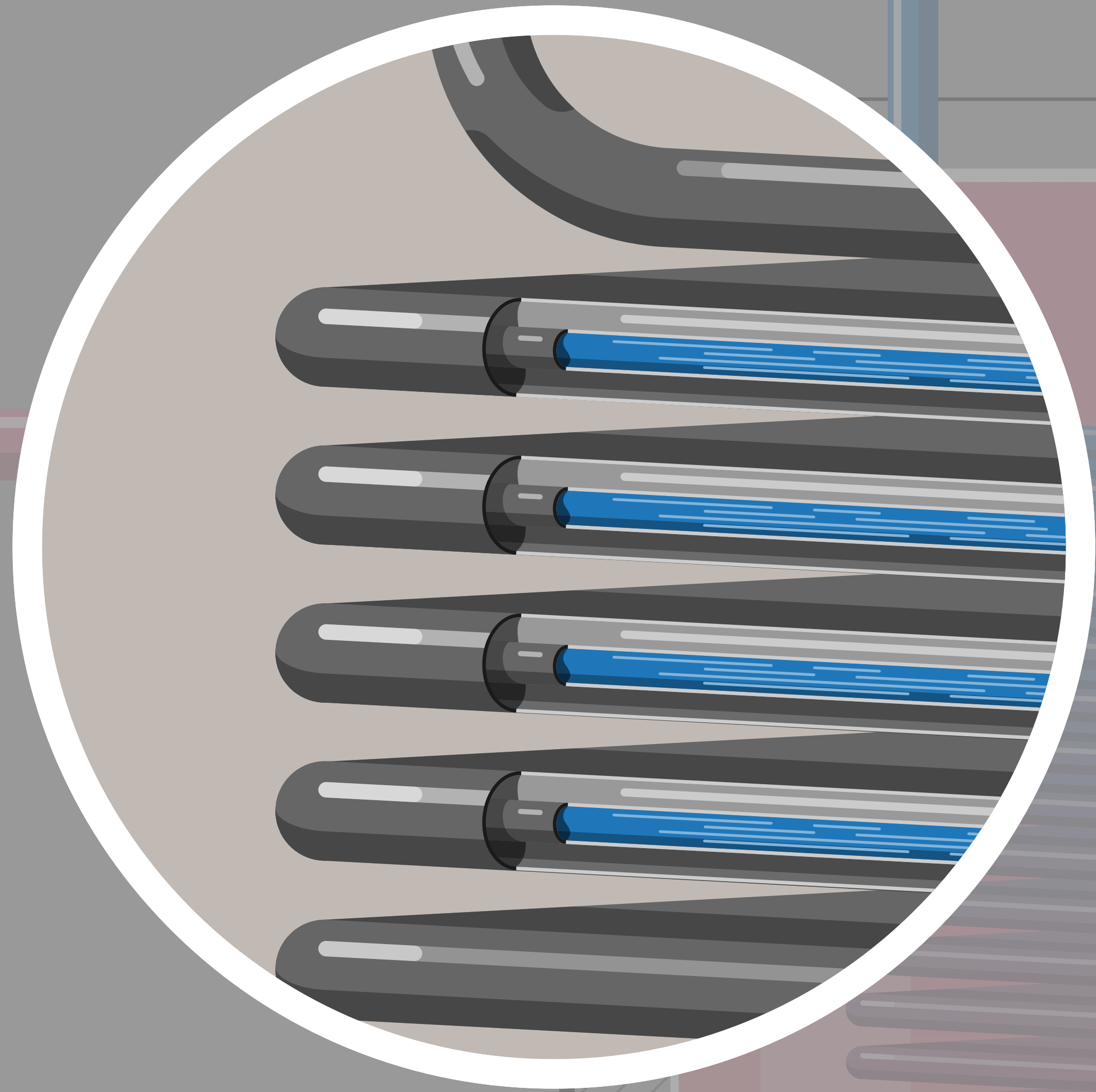

# PATENTED TECHNOLOGY

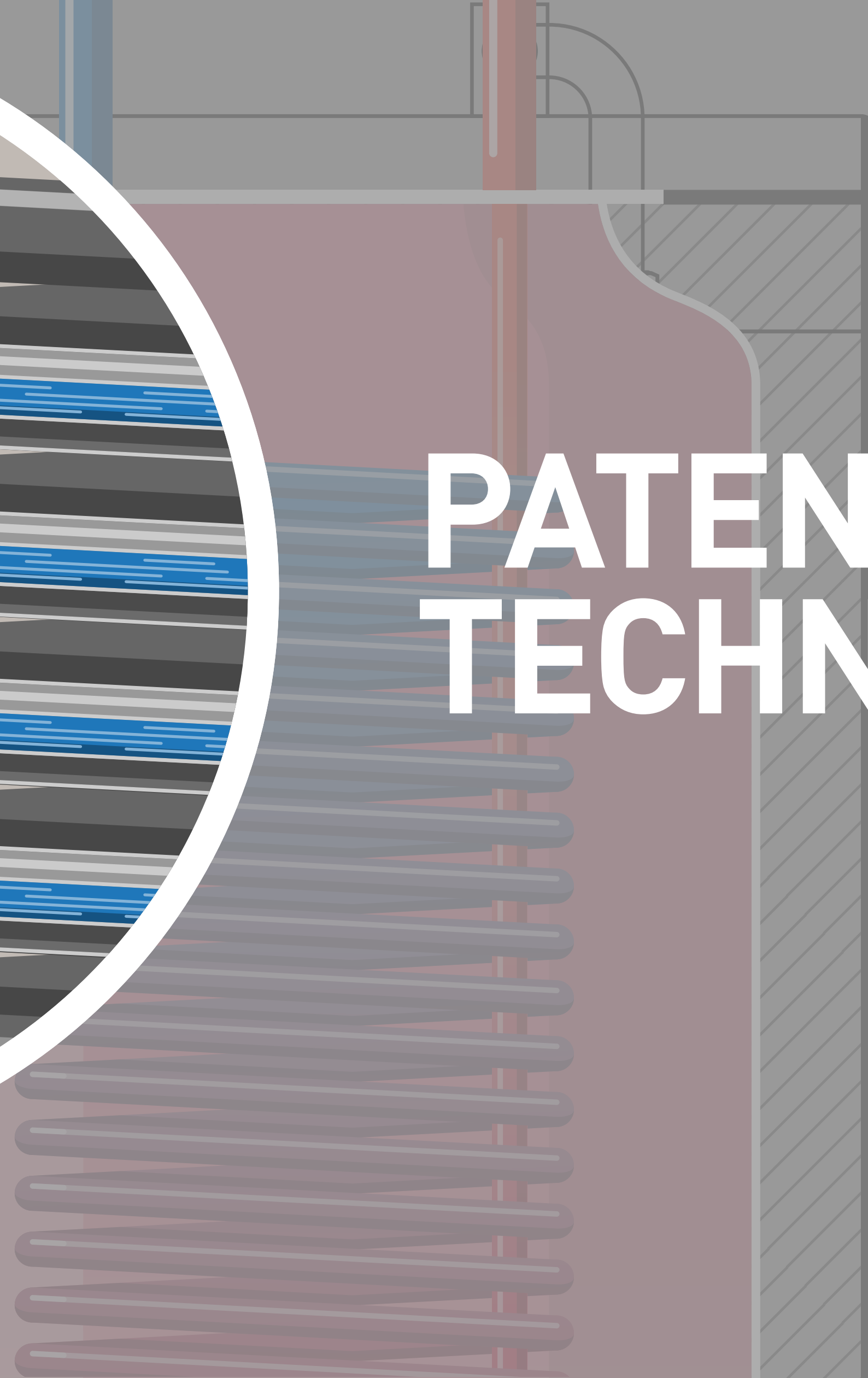

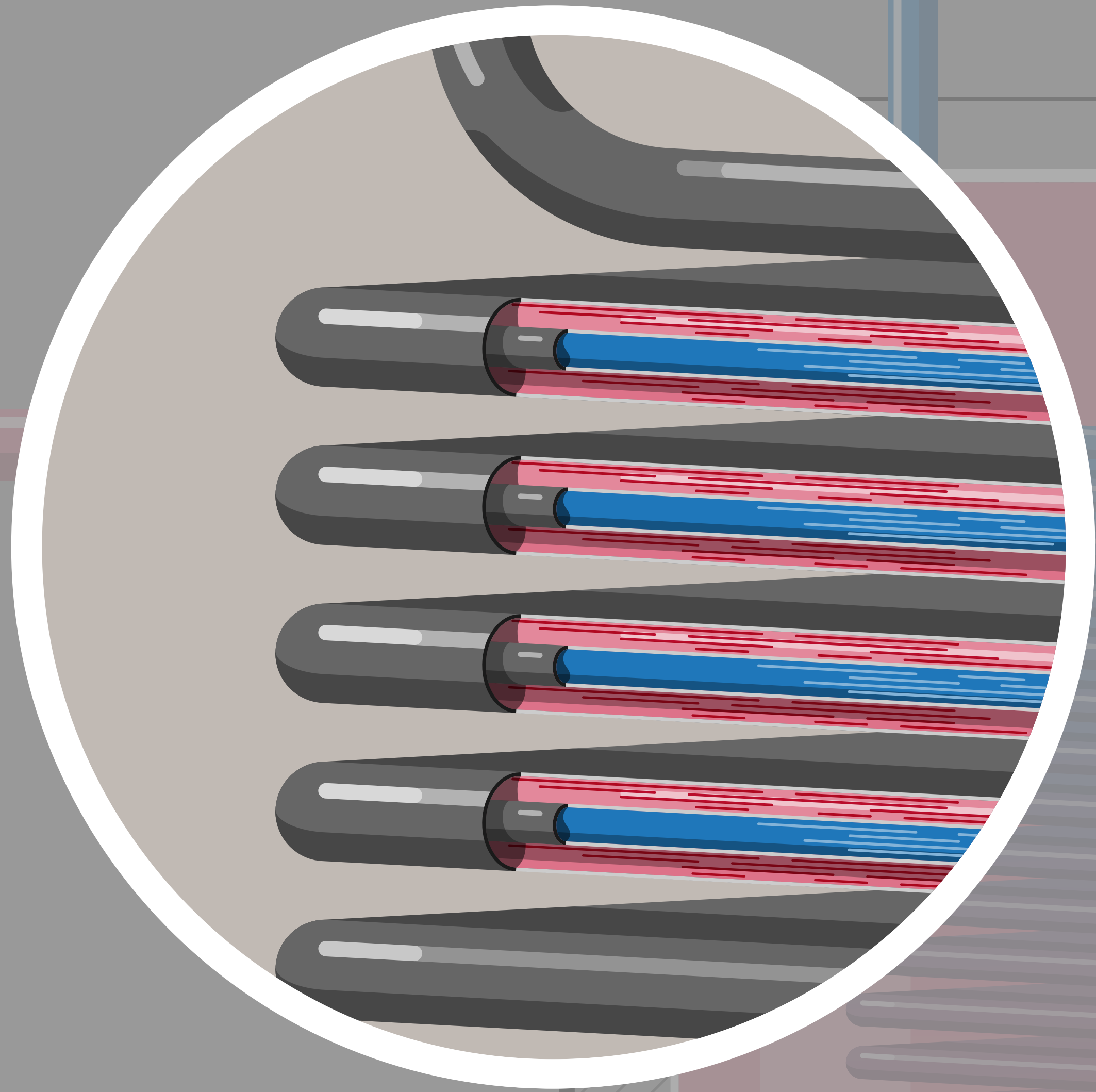

# PATENTED TECHNOLOGY

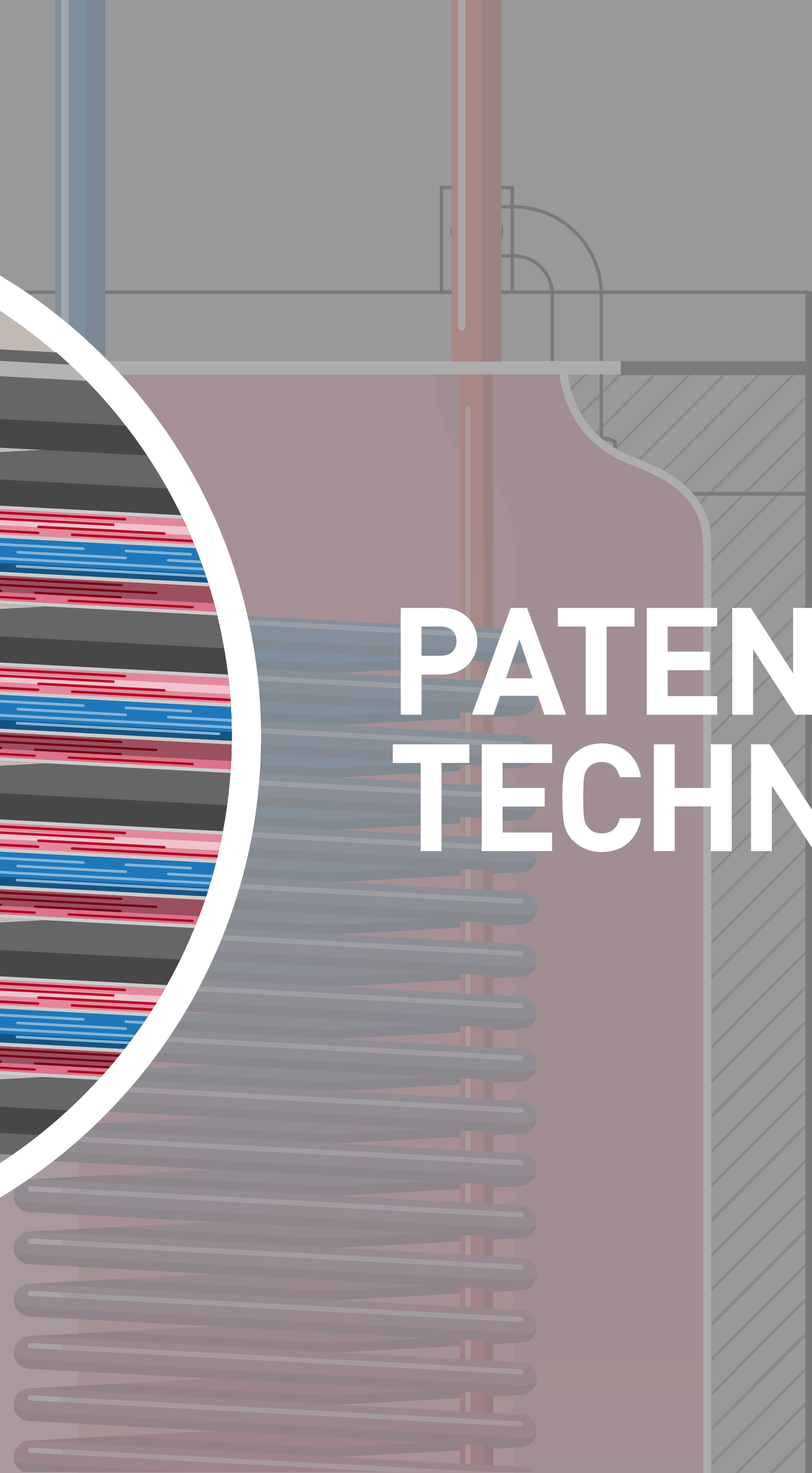

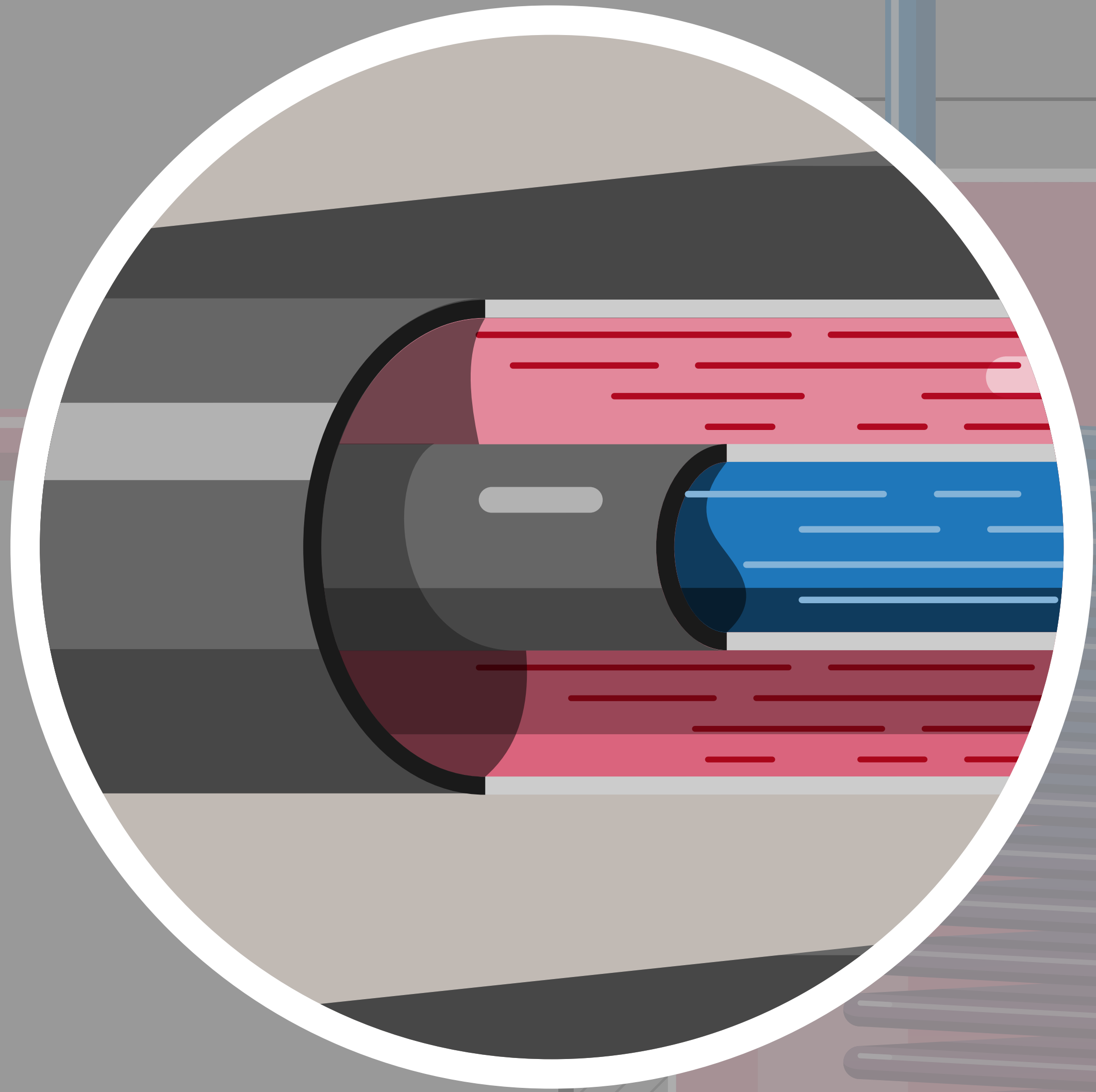

# PATENTED TECHNOLOGY

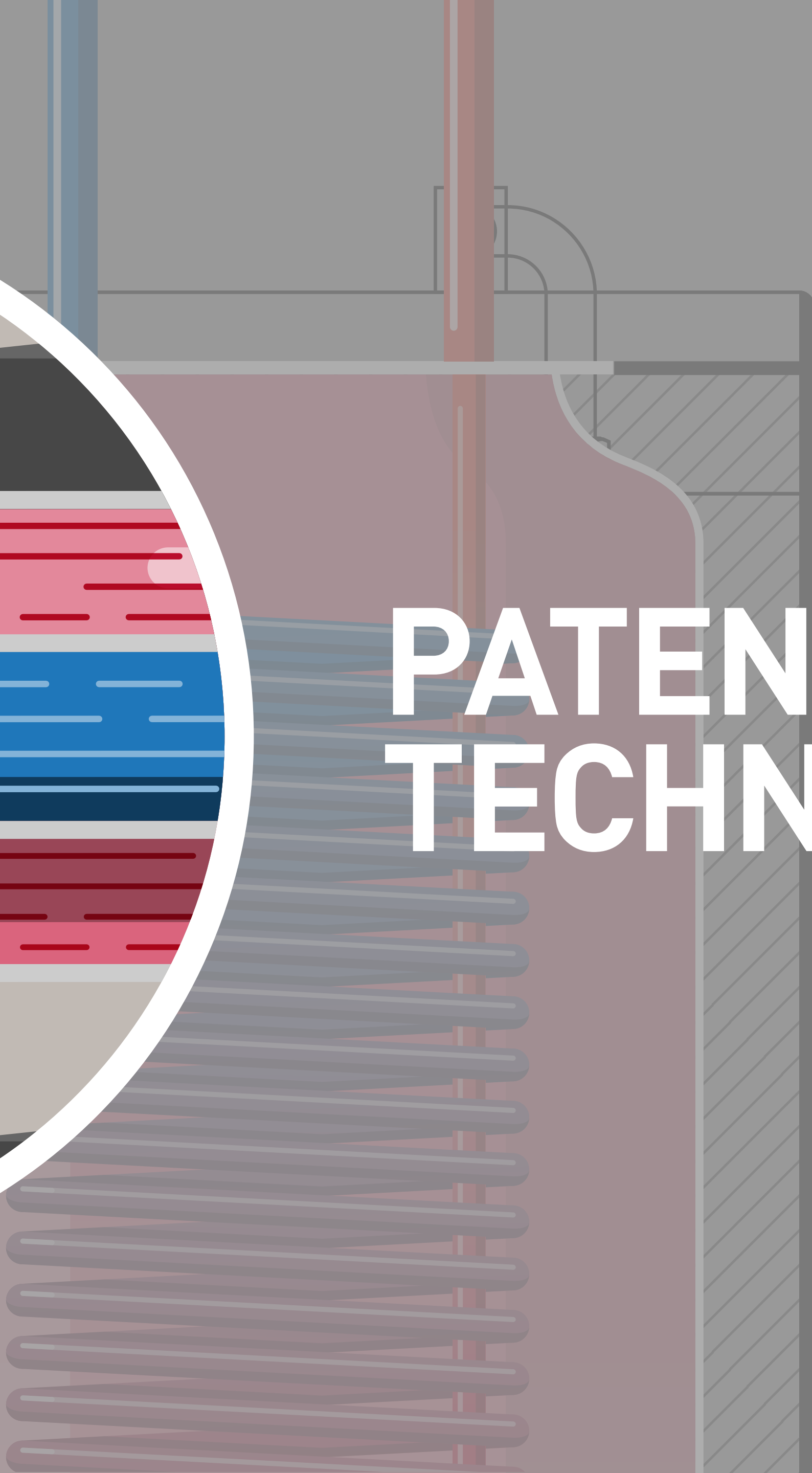



14a

