

LADDOMAT® 21-60 & 21-100

User and installation instructions



Laddomat 21-100



Laddomat 21-60

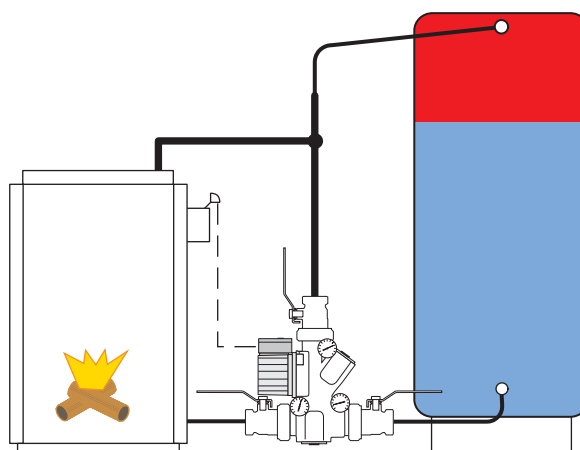

Laddomat 21

LADDOMAT®

by  Termoventiler

Språk/Languages:

3-8	Svenska
9-14	German
15-20	English
21-26	Finnish
27-32	French
33-38	Italian
39-44	Spanish
45-50	Russian
51-56	Polish
57-62	Slovenian
63-68	Czech
69-71	Spare parts list Laddomat 21-60
72-74	Spare parts list Laddomat 21-100

LADDOMAT®

by  Termoventiler AB

Termoventiler AB

Nolhagavägen 12

SE-523 93 Marbäck

Tel. +46 (0) 321 - 261 80

Fax. +46 (0) 321 - 261 89

info@termoventiler.se

www.laddomat.eu

Affiliated company/Branch

TV Termoventiler GmbH

Chemnitzer Straße 71

DE-09212 Limbach-Oberfrohna

Tel. +49 (0) 3722 - 505 700

Fax. +49 (0) 3722 - 505 702

info@termoventiler.de

www.laddomat.de

EC - Declaration of conformity:

Laddomat 21-60 and Laddomat 21-100, as delivered, are CE-certified according to relevant provisions.



**ErP
READY
2015**

APPLIES TO
EUROPEAN
DIRECTIVE
FOR ENERGY
RELATED
PRODUCTS

All high efficiency pumps applies to European directive for energy related products.
ErP 2009/125/EC

With reservation for possible typing errors.

Description of functions

Laddomat 21 is designed to...

- ...allow the boiler to reach a high working temperature soon after firing.
- ...to preheat the cold tank water in the bottom of the boiler so that the boiler does not rust away due to condensation.
- ...charge the tank with water at a high and even temperature and low flow, to ensure optimal layering in the tank.
- ...transfer the residual heat in the boiler to the tank after the fire has gone out.
- ...in the event of electrical power failure stopping the pump, transfer the heat in the boiler to the tank through self-circulation.

Operation

Laddomat 21 functions fully automatically provided that pump start and stop is automated. See page 16.

The settings described in this User manual are normally made only once.

The Laddomat requires no special supervision or service.

NOTE! Diagrams in this brochure only describe connection principles. Each installation must be measured and carried out according to the applicable regulations.

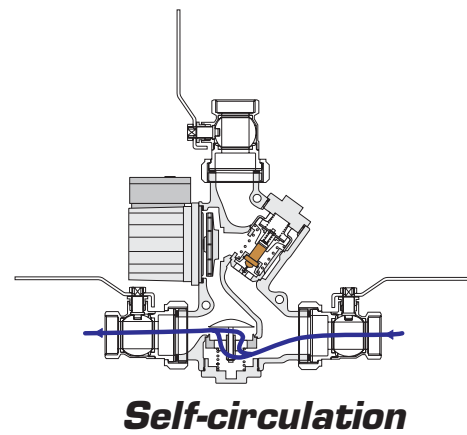
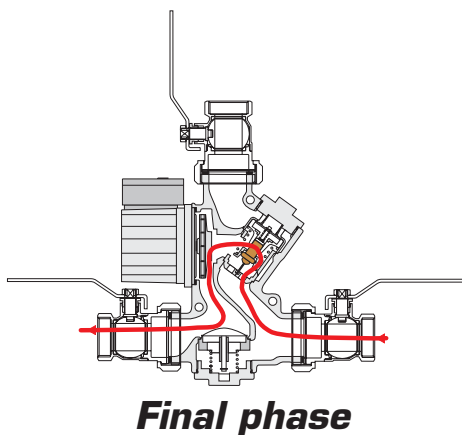
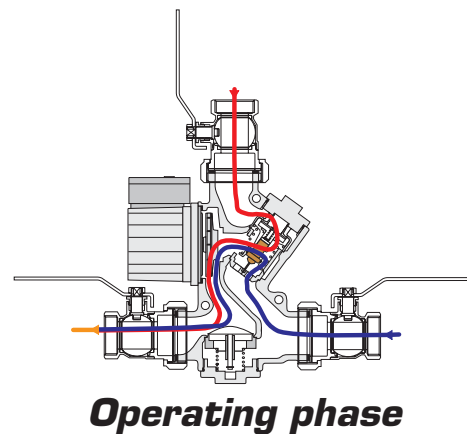
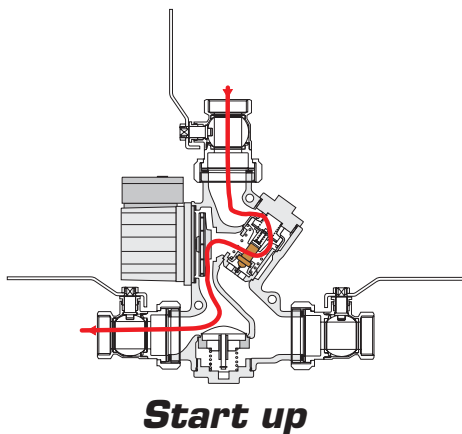

Technical data Laddomat 21-60

Pump:	Laddomat LM6 Laddomat LM6A ErP 2015
Connection:	3 x Cu28 with lever 3 x R32 with lever
Opening temperature:	53°, 57°, 63°, 66°, 72°, 78°, 83° or 87°C
Max. boiler output:	60 kW

Technical data Laddomat 21-100

Pump:	Wilo RS25-7 Wilo Yonos Para ErP 2015
Connection:	3 x R32 with lever
Opening temperature:	53°, 57°, 63°, 66°, 72°, 78°, 83° or 87°C
Max. boiler output:	120 kW

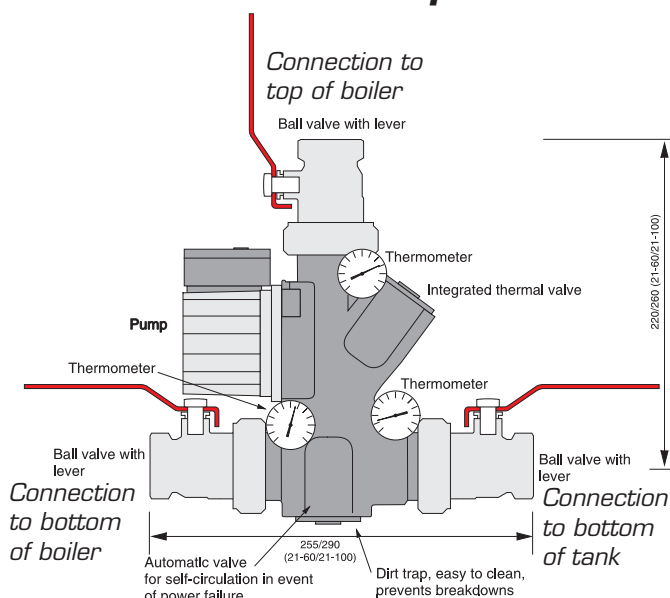

Dimensioning

Generous pipe dimensions and short lengths guarantee operating reliability, even when the demand for heat is high. This also allows effective self-circulation in the event of power failure.

Recommended pipe dimensions for a maximum boiler-to-tank distance of 2 m. Total length boiler-tank-boiler would then be 2 + 2 m + 6 bends. 1 bend is equivalent to 1 m pipe length.

Boiler with max output* up to: Laddomat 21-60:

45 kW min. 28 Cu pipe or R25
60 kW min. 35 Cu pipe or R32

Laddomat 21-100:

80 kW min. 35 Cu-rör alt. R32
100 kW min. 42 Cu-rör alt. R40
120 kW min. 54 Cu-rör alt. R50

Flow:

At the above pipe dimensions, Laddomat 21-60 gives 2 – 3 m³/h. Laddomat 21-100 gives 3 – 4 m³/h. See flow diagram below.

The dimensions must be increased for longer distances.

The maximum distance between boiler and tank is 6 m. Total length would then be 6 + 6 m + 6 bends.

Maximum distance and self-circulation

With longer distance, the Laddomat should be placed closer to the accumulator. Remember that flow capacity will decrease, both when it comes to pump flow as well as self-circulation. See example on page 6.

If there are special requirements for self-circulation, the pipes must be dimensioned accordingly.

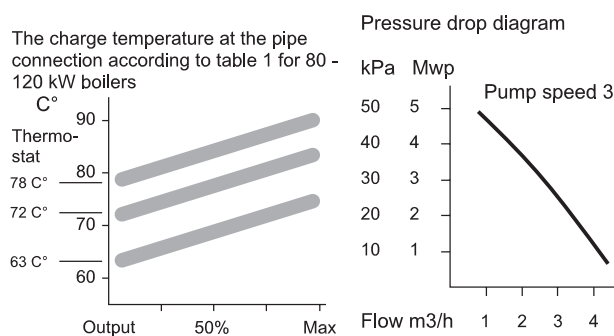
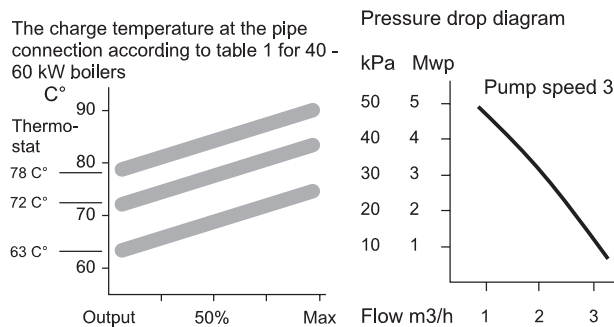

*Boiler output:

There is a difference between the nominal output and the maximum output of a boiler. The maximum output can be as much as 30-50% higher than the boiler's nominal output.

Example: If the boiler's nominal output is 40 kW, the max output can reach up to 60 kW.

This is very important to include in the calculation when dimensioning the system.

Connection

Laddomat 21 must always be connected in the upright position as shown in the diagrams.

Place Laddomat 21 near the boiler and at the level of the boiler's bottom output.

Pipe-runs must be as short as possible and have the minimum number of bends. Make sure that all air pockets are eliminated.

The diameter of the pipe from the top of the boiler to the T-pipe and down to the Laddomat 21 must be as large as possible. This gives low water velocity, and allows air released in the boiler to separate out in the expansion chamber or the vent.

Starting and stopping the charging pump

The speed control on the circulation pump must be in position 3.

NOTE! Check that the control is not at the lowest speed or a neutral position because this can prevent the pump from starting.

The pump can be started by a flue thermostat. If extra safety is required, a water thermostat can be connected in parallel. See image to the right.

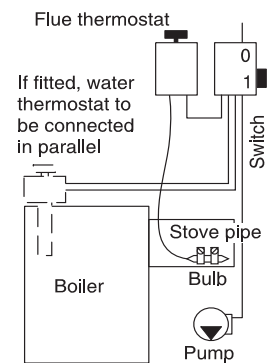

Expansion vessel

The expansion vessel must be sufficiently large, at least 5–10% of the total volume for an open system.

If a pressure vessel is installed, this must be at least 10–20% of the total volume. Each installation must be specially dimensioned in accordance with the manufacturer's instructions.

Check that the operating pressure, when the system is cold, is never lower than the height difference between the pressure gauge and the highest radiator + 2 metre water pillar (mwp, 1 m = 0,1 bar).

Radiator system

To make the maximum use of the storage tank, it is very important that the radiator system is fitted with:

1. Automatic by-pass control like Thermomatic with flow sensor and room sensor is ideal for this purpose, thanks to its ability to sense the heating needs of the house rapidly. The automatic by-pass control always matches heat output exactly to requirements.

2. Thermostatic valves with integrated pressure reduction devices, which are set to suit the radiator size.

Both measures are intended to reduce the flow and so reduce the return temperature, without raising the delivery temperature. The lower the return temperature, the longer the heat in the tank lasts.

Connecting to 1 tank

1. The pipe-runs shown on the diagram are optimised to minimise air-related operating interruptions.
2. The hot water pipe to the by-pass valve can be connected in two ways.
 - A. Approx 30 cm from the top of the tank to prioritise domestic hot water.
 - B. On the charge line connection to the tank to prioritise heating. The connection is directed downwards to prevent air rising to the radiators.

Laddomat 21 can easily be reversed for right-hand mounting. Just move the thermometers to the other side.

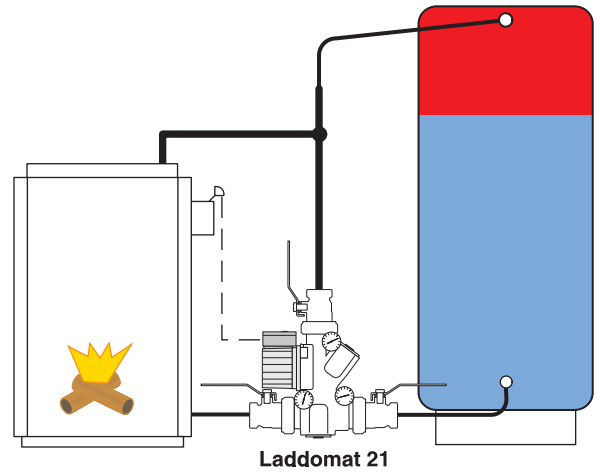
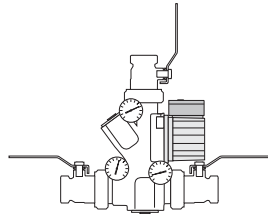

Connecting 2 tanks

The tanks must be located up against each other, and as close as possible to the boiler. The pipe-runs from the bottom of the tanks are always laid close to the floor.

It is important that the flow to the tanks during charging and discharging is distributed equally. If the system is connected incorrectly, then charging will be cut off when tank 1 is full of hot water which will reach the boiler before the other tanks are completely filled. Tank 2 will be virtually unused.

If the system is connected incorrectly, the warm water and the heat will run out earlier than estimated after the burner has stopped, since tank 1 will cool down more quickly than the other.

If these requirements cannot be met, there are other connection options.

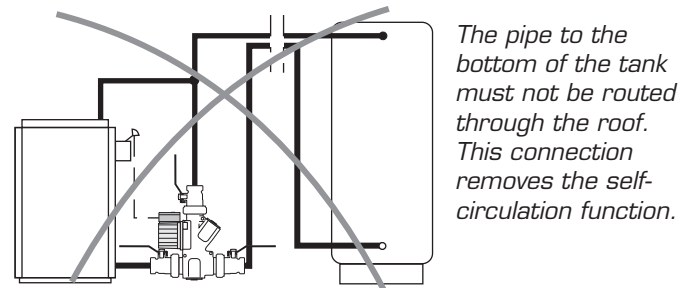

The pipe to the bottom of the tank must not be routed through the roof. This connection removes the self-circulation function.

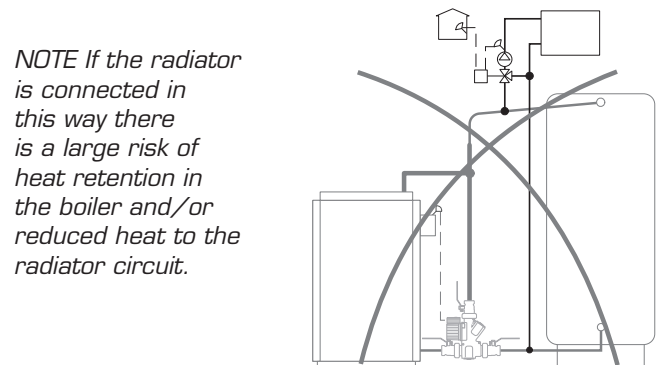

NOTE If the radiator is connected in this way there is a large risk of heat retention in the boiler and/or reduced heat to the radiator circuit.

Equal pipe lengths

To achieve equal resistance, it is essential to use approximately the same pipe-lengths to the tanks, this is achieved by:

1. Connecting the charging circuit diagonally, A–A.
2. Connecting the radiator circuit diagonally, B–B.

In addition, the dimension of the pipes between the tanks must be large enough to facilitate self-circulation between the tanks. It is an advantage if the tanks are connected together in the centre, to further distribute the heat.

Connecting the by-pass valve

The hot water port is connected at B, which prioritises hot water, or at B₁, which prioritises heating.

Electrical immersion heater operation

When operating solely on the electrical immersion heater, it is an advantage only to heat the first tank to prevent heat loss. Shut off the other tank using the valve at the bottom of the tank.

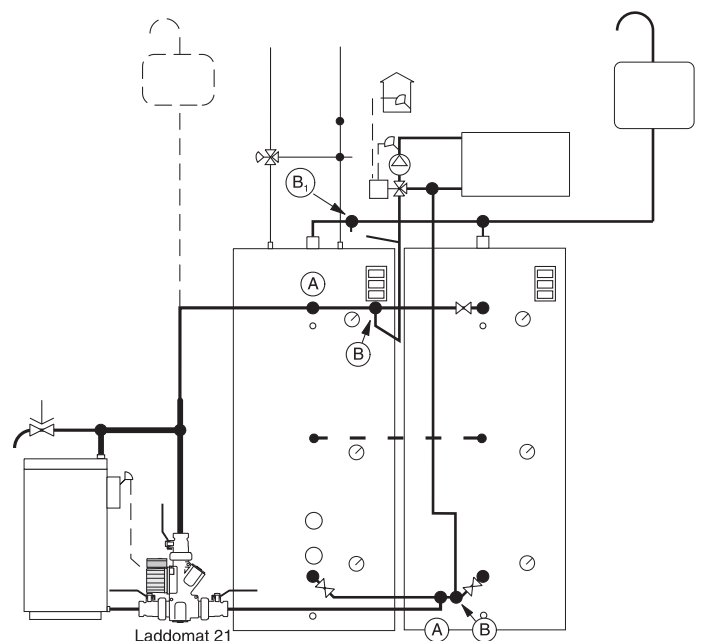

Connection suggestions

Installation with open expansion vessel

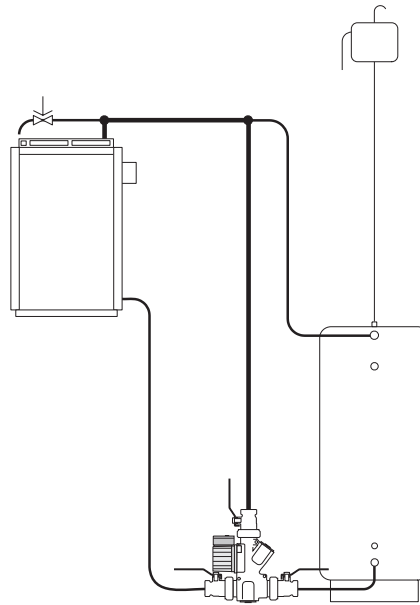
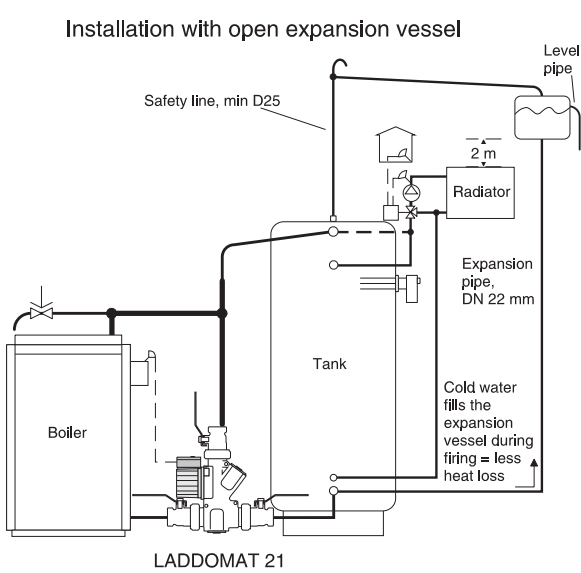

NOTE
This type of installation will remove the self-circulation function. The check valve must be blocked to lower the risk of keeping the boiler warm. See picture 5 on next page for instruction.

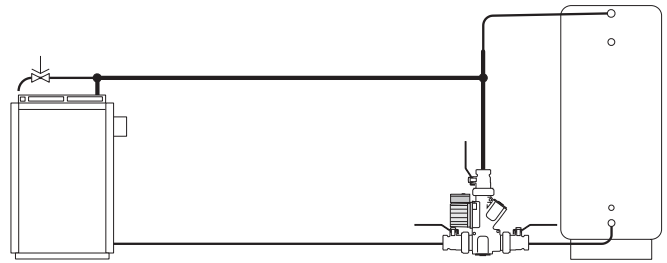
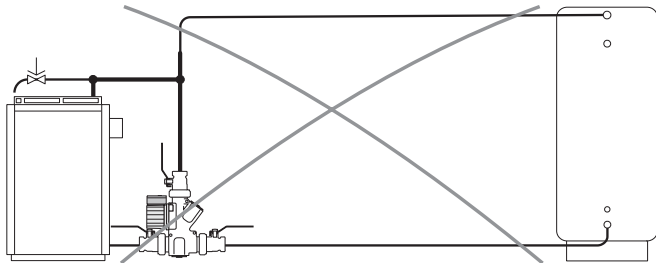

*Recommended installation with longer distance
To make sure the charging will work, the Laddomat should be placed near the accumulator.
NOTE long distance means lower flow, which means lower capacity for the system.*

Bottom connection of the expansion vessel gives reduced heat losses.

NOTE See information on page 16 about the expansion vessel

Connecting a pressurised expansion vessel

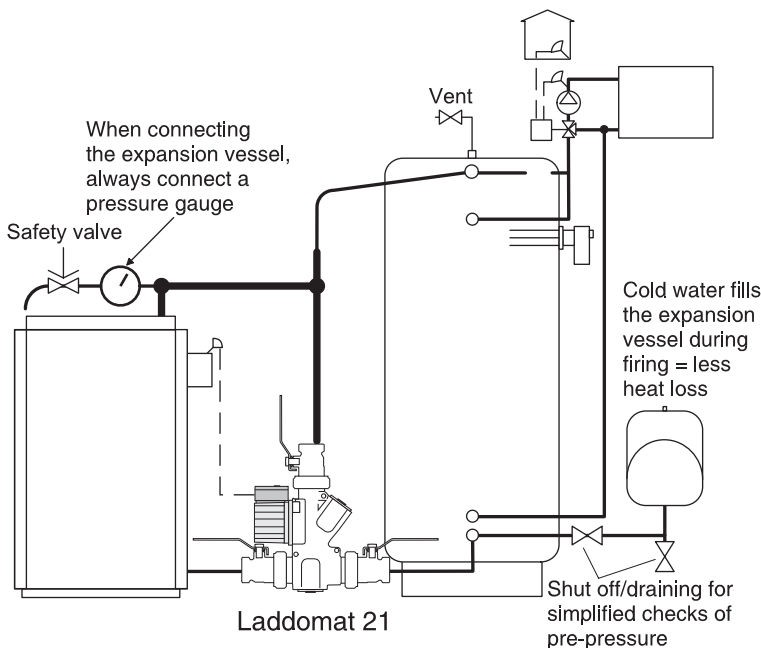

Alternative installation with open expansion vessel

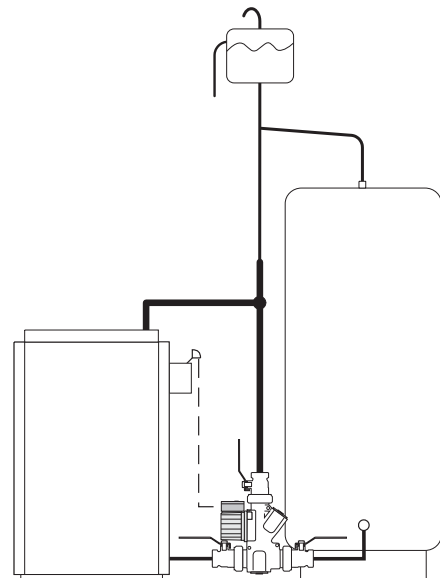

Thermostat cartridge

The thermostat cartridge is available as a spare part, and may need to be replaced more often if it is regularly exposed to temperatures close to, or above, boiling point.

The number is engraved on the cartridge.

See spare parts list for options

Service

Before carrying out any servicing work, close the three shut-offs by turning the lever on the valves at right angles to the direction of the pipe. This makes it easy to access the pump, thermal valve and check valve for service.

If operating interruptions still occur, even though the system has been bled, there may be dirt such as lint, tape or thread swarf stuck in the coupling. Disassemble and clean. Clean all sealing surfaces when reassembling:

1. The thermal valve
2. The self-circulation valve
3. The pump impeller

In some installations, there are problems with extremely high levels of contaminants. These can form deposits inside the pump, which may result in stoppages.

Instructions for replacing the thermostat in Laddomat 21

Check that the pump is switched off.

Close the three shut-off valves.

Unscrew the cover opposite the pump.

Remove the cover with the spring, plunger and thermostat from Laddomat 21.

The thermostat is held in place on the plunger by an O-ring. Detach the thermostat from the plunger carefully using a screwdriver (see image on right).

Push the new thermostat into the plunger.

Reinstall the cover with the spring, plunger and thermostat.

Open the shut-off valves.

Wait a few minutes before starting the pump to allow any air to rise and escape from the system.

The installation is now ready for use.

Blocking the check valve

If you, for some reason, want to completely shut off the self circulation function, the check valve must be blocked.

Use the blocking clip, placed at the bottom of the EPP-insulation (Picture 3), to block the check valve.

The clip is then fastened around the check valve axis according to picture 5.

To reach the axis, the spring needs to be removed.

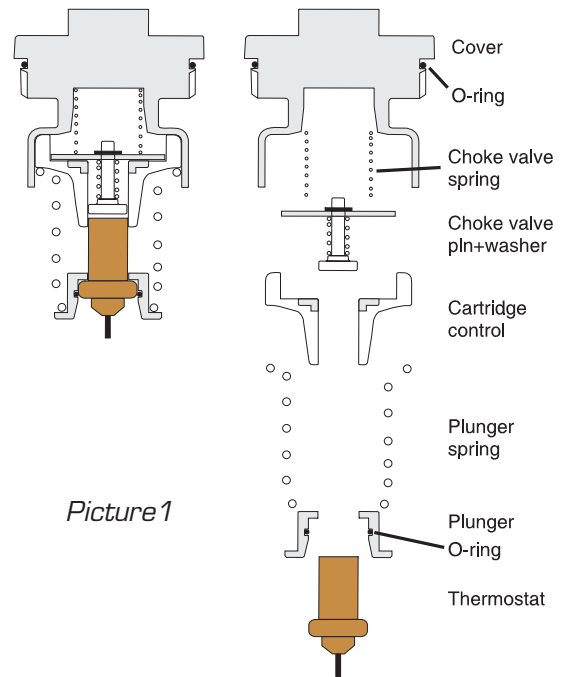

Picture 1

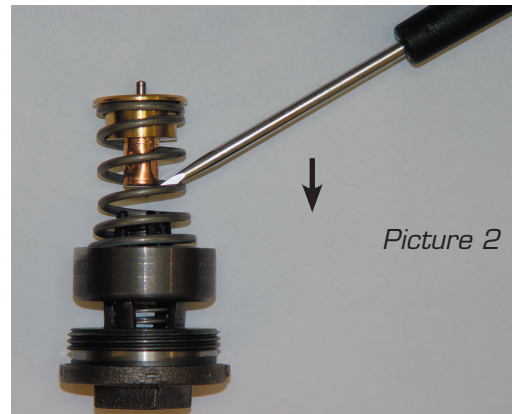

Picture 2



Picture 3

The blocking clip is mounted here.



Picture 4

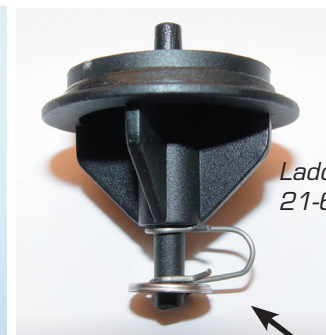

Picture 5

Laddomat 21-60



Laddomat 21-100

Blocking clip

Installation & setting pump Laddomat LMXA

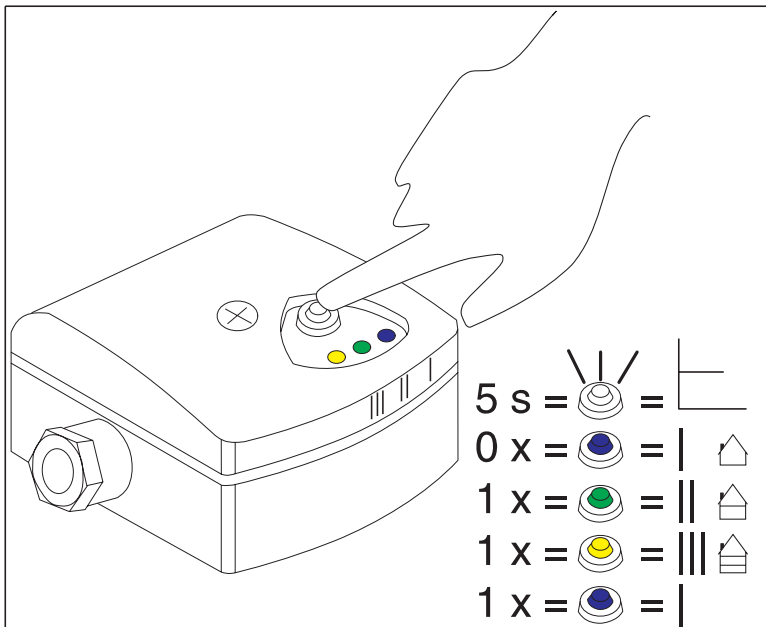
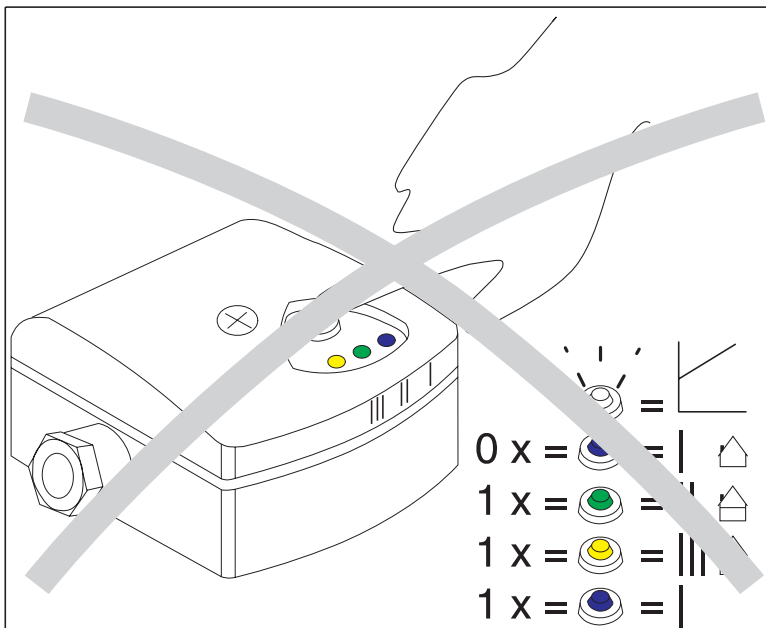

Blue
Green
Yellow
Blue

Laddomat LM6A

I	7-50 W	16 W	
II	10-50 W	34 W	
III	12-50 W	50 W	

230 V ± 10 %, 50 Hz

Laddomat 21-60
Spare parts list



Termoventiler AB

Nolhagavägen 12
SE-523 93 MARBÄCK

Tel +46 (0) 321 - 261 80 info@termoventiler.se
Fax +46 (0) 321 - 261 89 www.termoventiler.eu

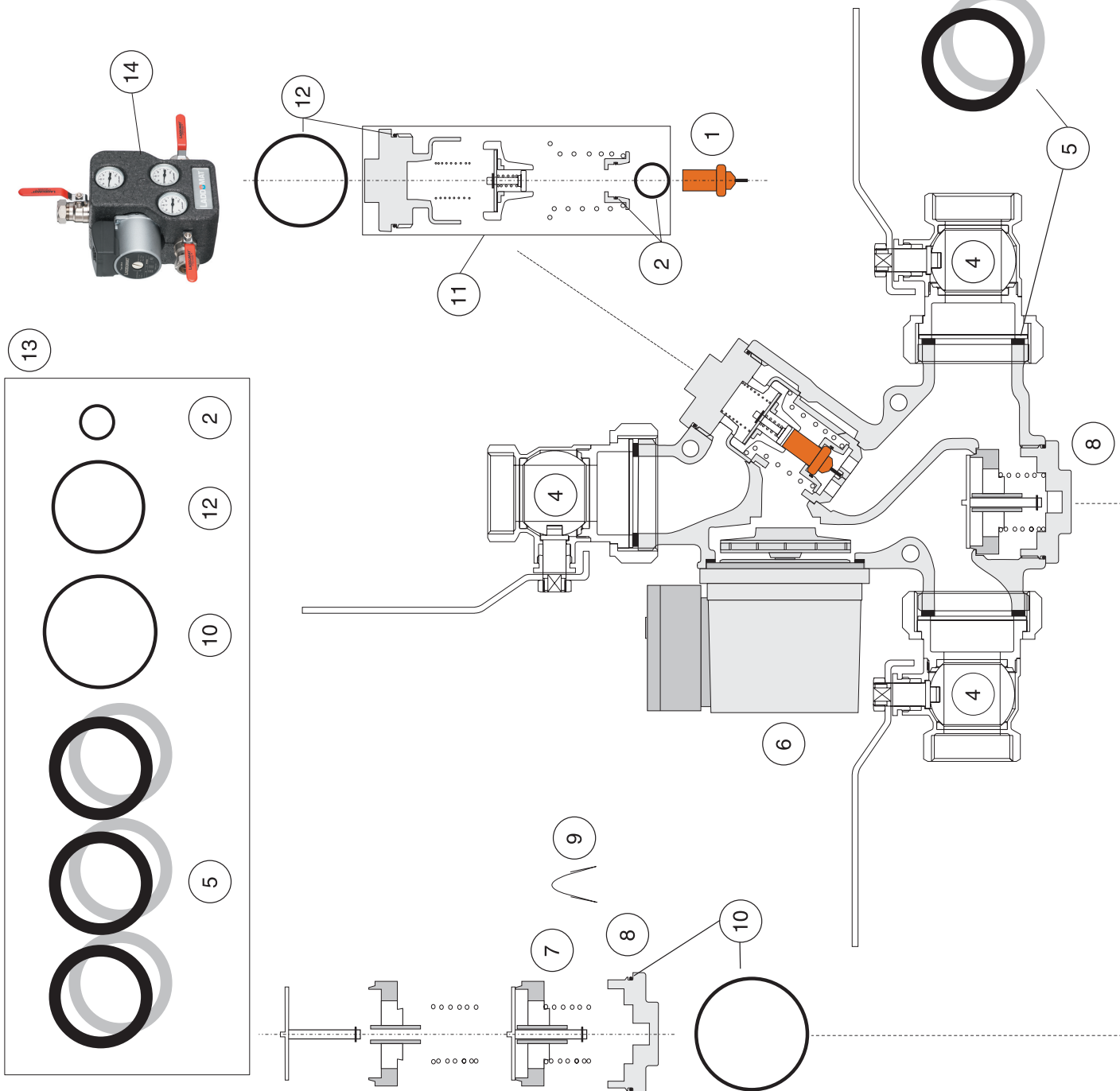

Pos	Part no.	Description
1	110053	Thermostatic element 5840, 53°C
1	110057	Thermostatic element 8749, 57°C
1	110063	Thermostatic element 5839, 63°C
1	110066	Thermostatic element 1240, 66°C
1	110072	Thermostatic element 8719, 72°C
1	110078	Thermostatic element 1456, 78°C
1	110083	Thermostatic element 1467, 83°C
1	110087	Thermostatic element 8222, 87°C
2		O-ring 17, 1x1.6, for thermo. element
3	383004	Thermometer
4	141015	Ball valve R40-Cu28, with lever, incl. gasket
4	141301	Ball valve R40-R32, with lever, incl. gasket
5a		Flat gasket, R40
5b		Flat gasket FIBRE, R40
6a	146035	Pump Laddomat LM6
6b	146044	Pump Laddomat LM6A, ERP 2015
7	212602	Check Valve LM21-60, complete with spring
8	412116	Check valve cover, LM21-60
9	452105	Blocking clip for check valve
10		O-ring 31, 42*2.62 epdm, for CV-cover LM21-60
11	212108	Regulation kit LM21-60/100
12		O-ring 44, 12*2.62 epdm for cover
13	110004	Gasket set for LM21-60
14	164002	EPP-insulation for LM21-60

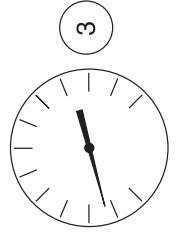

Laddomat 21-100 Spare parts list

Termostater AB

Nohagavägen 12
SE-523 93 MARBÄCK

Tel +46 (0) 321 - 261 80

info@termostater.se

Fax +46 (0) 321 - 261 89

www.termostater.se

Pos	Part no.	Description
1	110053	Thermostatic element 5840, 53°C
1	110057	Thermostatic element 8749, 57°C
1	110063	Thermostatic element 5839, 63°C
1	110066	Thermostatic element 1240, 66°C
1	110072	Thermostatic element 8719, 72°C
1	110078	Thermostatic element 1456, 78°C
1	110083	Thermostatic element 1467, 83°C
1	110087	Thermostatic element 8222, 87°C
2		O-ring 17,1x1,6, for thermo. element
3	383004	Thermometer
4	141012	Ball valve R32-R50, with lever, incl. gasket
5a		Flat gasket, R50
5b		Flat gasket FIBRE, R50
6	146032	Pump Wilo RS25-7-3
7		Flat gasket, for pump
8	212101	Check Valve LM21-100, complete with spring
9	412110	Check valve cover, LM21-100
10	452105	Blocking clip for check valve
11		O-ring 53,64*2,62 epdm, for CV-cover LM21-100
12	212108	Regulation kit 21-60/100
13		O-ring 44,12*2,62 epdm for cover
14	110003	Gasket set for LM21-100
15	164003	EPP-insulation for LM21-100

